

bovenaanzicht

10mm diameter uitsparing voor verankering van dorpel met bevestigingsstift

type 155/180

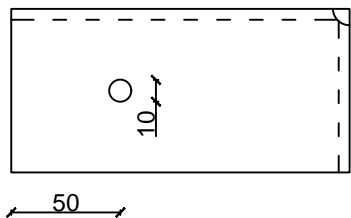

type 125/180

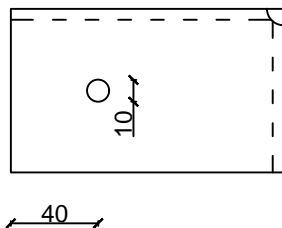

type 95/180

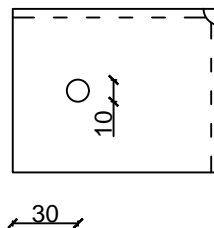

type 65/180

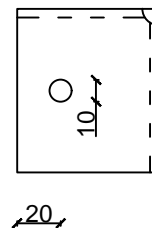

aannames

Min. 2 stuks per dorpel

Maximale h.o.h.afstand 1meter

beschouwde krachten:

- 0.24-0.42kN/m dorpel (perm.)
- 1 kN/m persoon (var.)

M12 chemische verankering min. op 6cm van betonrand

zijaanzicht

type 155/180

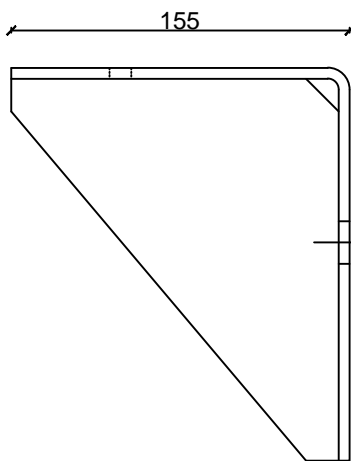

type 125/180

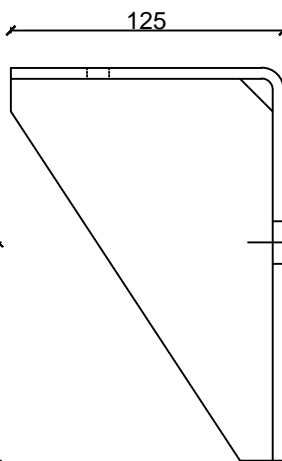

type 95/180

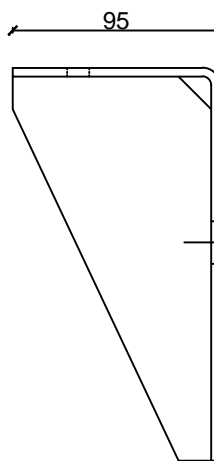

type 65/180

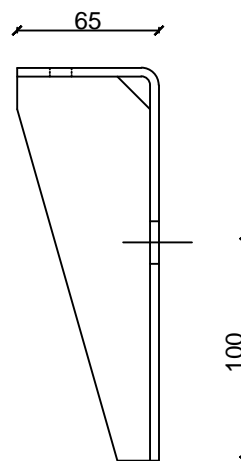

vooraanzicht

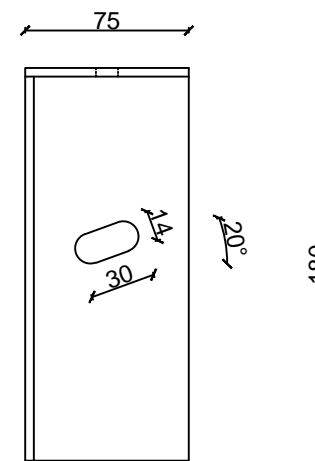

Uitkraging (Crépi):

dorpel max. 6cm ongesteund laten

type 155/180: isolatie 170-200mm (excl. crépi)

type 125/180: isolatie 140-170mm (excl. crépi)

type 95/180: isolatie 110-140mm (excl. crépi)

type 65/180: isolatie 80-110mm (excl. crépi)



SCALDEX

Kasteelstraat 160
9255 Buggenhout
T 052 42 54 05
F 052 42 44 39
info@scaldex.be

SILLDEX

dorpelsteun